

immunity

PRODUCT CATALOGUE



**SURGICAL
DRAPES & SETS**

Content

Universal sets.....	4
U-split sets.....	7
Orthopaedic sets.....	8
Urology and gynaecology sets.....	12
Ophthalmic sets.....	16
Other sets.....	17
Speciality drapes.....	18
Utility drapes + hospidrape.....	21
Adhesive drapes.....	22
Aperture drapes and adhesive aperture drapes.....	24
Table covers and components.....	26
Equipment drapes.....	27
Incision film.....	28
Accessories.....	29
Surgical gowns.....	30
Label information in accordance with - EN ISO 15223-1 and EN 1041+A1.....	31
Triple package system information.....	31





DISPOSABLE SURGICAL DRAPES







Disposable surgical drapes

Disposable surgical drapes, gowns, sets and accessories which have been developed to enhance the safety and comfort of the patient, the surgeon and medical staff.

- Safety strong - impermeable
- Extra large absorbent patches
- Very low linting
- Stays well in place, is not slippery
- High puncture resistance - very durable

-  Suitable for procedures with low fluid levels
-  Suitable for procedures with moderate fluid levels
-  Suitable for procedures with high fluid levels

- 1 Large and very efficient absorbent patches, new structure
- 2 Blue/grey nonwoven, very low linting
- 3 A highly elastic multicomponent PE-layer moisture barrier, puncture resistance
- 4 White backsheet with very low linting more comfort to the patient, more strength

-  Absorbent and impermeable fully glued 3-layer material
-  Absorbent and impermeable 2-layer material
-  Absorbent patch - reinforced material
-  Polyethylen foil
-  Elastic material
-  Adhesive edge

Easily identifiable integrated tube holders in drapes with absorbent patch



UNIVERSAL SETS

Universal set ECO

REF 100 003

- 1 op-tape 9 x 50 cm
- 1 Mayo stand cover 79 x 145 cm, reinforced
- 2 hand towel 30,5 x 34 cm
- 2 adhesive drape 75 x 90 cm (repositionable)
- 1 adhesive drape 180 x 180 cm (repositionable)
- 1 adhesive drape 150 x 240 cm (repositionable)
- 1 instrument table cover 150 x 190 cm

Pack count: 1/6/12

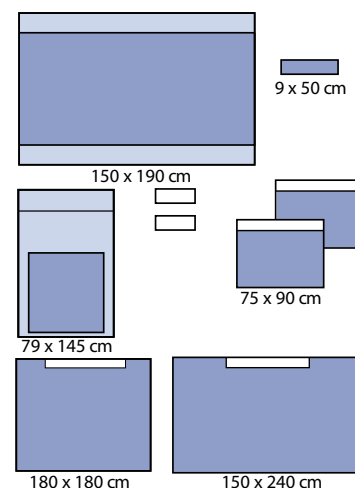

Universal set - Basic

REF 100 005

- 1 op-tape 9 x 50 cm
- 1 Mayo stand cover 79 x 145 cm, reinforced
- 2 hand towel 30,5 x 34 cm
- 2 adhesive drape 75 x 90 cm
- 1 adhesive drape 180 x 180 cm
- 1 adhesive drape 150 x 240 cm
- 1 instrument table cover 150 x 190 cm

Pack count: 1/6/12

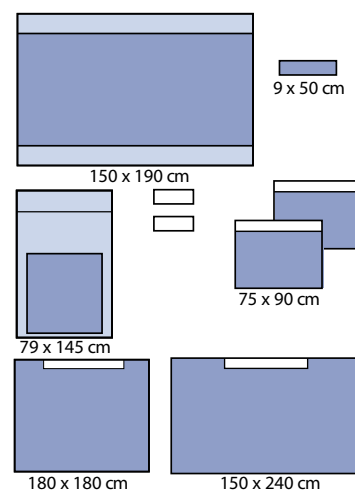

Universal set, reinforcement Medium

REF 100 006

- 1 op-tape 9 x 50 cm
- 1 Mayo stand cover 79 x 145 cm, reinforced
- 4 hand towel 30,5 x 34 cm
- 2 adhesive drape 75 x 90 cm, absorbent patches 15 x 50 cm, tube holders
- 1 adhesive drape 180 x 180 cm, absorbent patches 15 x 50 cm, tube holders
- 1 adhesive drape 150 x 240 cm, absorbent patches 15 x 50 cm, tube holders
- 1 instrument table cover 150 x 190 cm

Pack count: 1/6/12

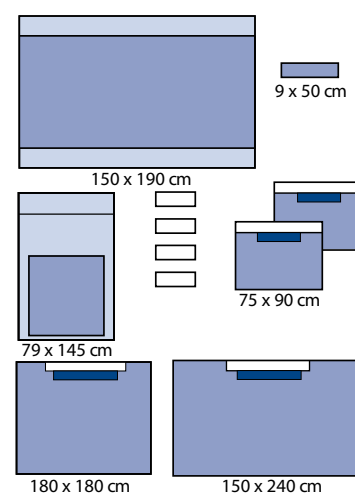

Universal set without Mayo, reinforcement Large

REF 100 007



- 1 op-tape 9 x 50 cm
- 4 hand towel 30,5 x 34 cm
- 2 adhesive drape 75 x 90 cm, absorbent patches 25 x 60 cm, tube holders
- 1 adhesive drape 180 x 180 cm, absorbent patches 25 x 60 cm, tube holders
- 1 adhesive drape 150 x 240 cm, absorbent patches 25 x 60 cm, tube holders
- 1 instrument table cover 150 x 190 cm

Pack count: 1/6/12

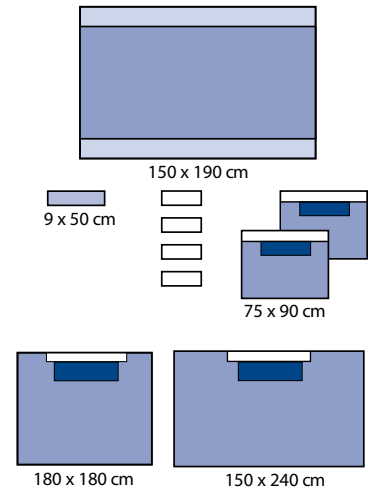

Universal set, reinforcement Medium, 3-layer

REF 100 010



- 1 op-tape 9 x 50 cm
- 1 Mayo stand cover 79 x 145 cm, reinforced
- 4 hand towel 30,5 x 34 cm
- 2 adhesive drape 75 x 90 cm, absorbent patches 15 x 50 cm, tube holders
- 1 adhesive drape 180 x 180 cm, absorbent patches 15 x 50 cm, tube holders
- 1 adhesive drape 150 x 240 cm
- 1 instrument table cover 150 x 190 cm

Pack count: 1/5/10

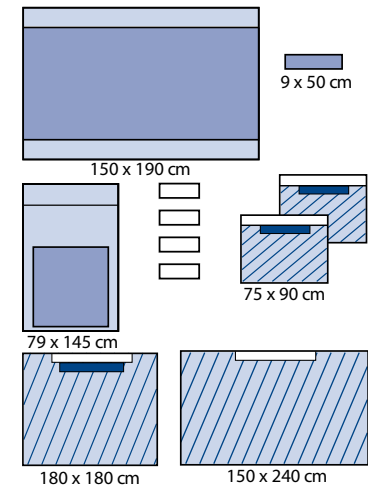

Universal set, reinforcement Large, 3-layer

REF 100 011



- 1 op-tape 9 x 50 cm
- 1 Mayo stand cover 79 x 145 cm, reinforced
- 4 hand towel 30,5 x 34 cm
- 2 adhesive drape 75 x 90 cm, absorbent patches 25 x 60 cm, tube holders
- 1 adhesive drape 180 x 180 cm, absorbent patches 25 x 60 cm, tube holders
- 1 adhesive drape 150 x 240 cm, absorbent patches 25 x 60 cm, tube holders
- 1 instrument table cover 150 x 190 cm

Pack count: 1/5/10

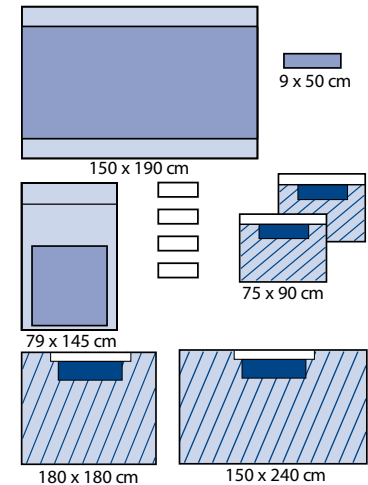

UNIVERSAL SETS

Universal set pediatric

REF 100 030

- 1 op-tape 9 x 50 cm
- 1 Mayo stand cover 79 x 145 cm, reinforced
- 4 hand towel 30,5 x 34 cm
- 2 adhesive drape 75 x 75 cm (repositionable)
- 2 adhesive drape 150 x 150 cm (repositionable)
- 1 instrument table cover 150 x 190 cm

Pack count: 1/7/14

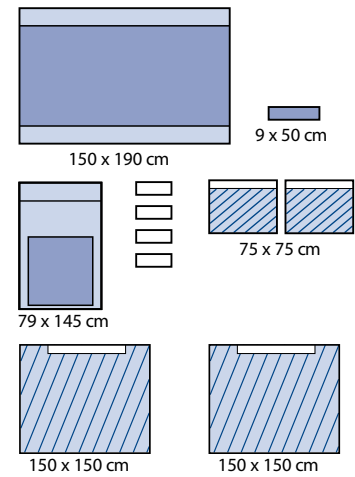

U-SPLIT SETS

U split sheet set M

REF 100 050

- 1 op-tape 9 x 50 cm
- 1 Mayo stand cover 79 x 145 cm, reinforced
- 4 hand towel 30,5 x 34 cm
- 1 adhesive drape 75 x 90 cm
- 1 adhesive split sheet 230 x 260 cm, split 10 x 100 cm, absorbent patches 75 x 140 cm, tube holders
- 1 adhesive drape 150 x 240 cm
- 1 instrument table cover 150 x 190 cm

Pack count: 1/4/8

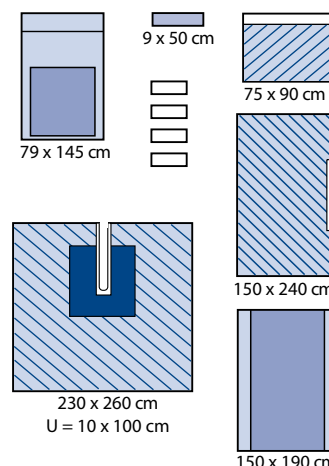

U split sheet set L, reinforced

REF 100 051

- 1 op-tape 9 x 50 cm
- 1 Mayo stand cover 79 x 145 cm, reinforced
- 4 hand towel 30,5 x 34 cm
- 1 adhesive drape 75 x 90 cm
- 1 adhesive split sheet 230 x 260 cm, split 20 x 100 cm, absorbent patches 75 x 140 cm, tube holders
- 1 adhesive drape 150 x 240 cm, absorbent patches 25 x 60 cm, tube holders
- 1 instrument table cover 150 x 190 cm

Pack count: 1/4/8

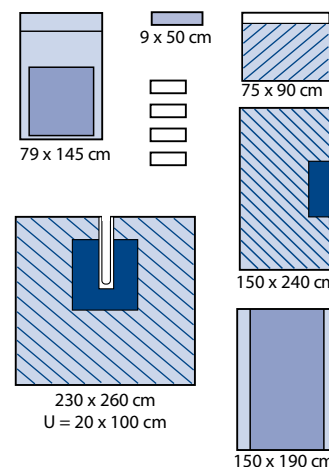

U split sheet set ECO

REF 100 055

- 1 op-tape 9 x 50 cm
- 1 Mayo stand cover 79 x 145 cm, reinforced
- 4 hand towel 30,5 x 34 cm
- 1 adhesive drape 75 x 90 cm
- 1 adhesive split sheet 230 x 260 cm, split 10 x 85 cm
- 1 adhesive drape 150 x 240 cm
- 1 instrument table cover 150 x 190 cm

Pack count: 1/5/10

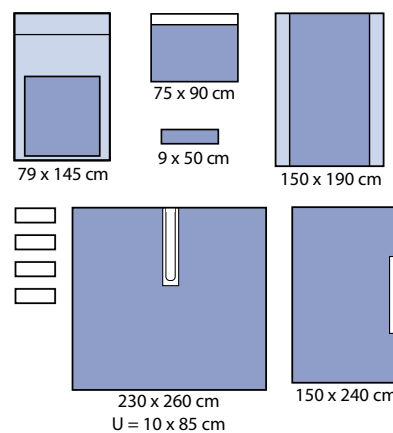

ORTHOPAEDIC SETS

Hip set ECO

REF 120 005



- 2 op-tape 9 x 50 cm
- 1 Mayo stand cover 79 x 145 cm, reinforced
- 1 stockinette 36 x 120 cm
- 1 utility drape 100 x 150 cm
- 1 adhesive drape 150 x 300 cm, absorbent patches 15 x 50 cm, tube holders
- 1 adhesive split sheet 230 x 260 cm, split 20 x 85 cm, absorbent patches 50 x 100 cm, tube holders
- 1 instrument table cover 150 x 190 cm

Pack count: 1/4/8

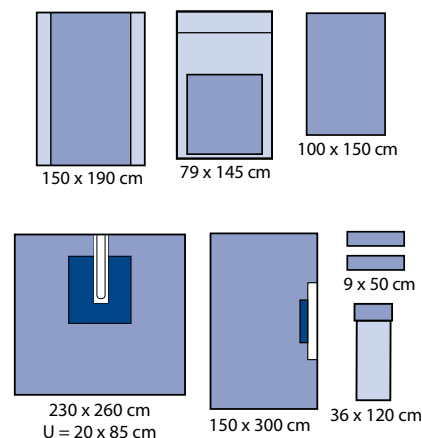

Hip set, reinforcement Large, 3-layer

REF 120 010



- 3 op-tape 9 x 50 cm
- 1 Mayo stand cover 79 x 145 cm, reinforced
- 4 hand towel 30,5 x 34 cm
- 1 elastic stockinette 30 x 120 cm
- 1 elastic support bandage 12 cm x 6 m
- 2 adhesive drape 75 x 90 cm, absorbent patches 25 x 60 cm, tube holders
- 1 adhesive drape 180 x 180 cm, absorbent patches 25 x 60 cm, tube holders
- 1 adhesive drape 150 x 240 cm, absorbent patches 25 x 60 cm, tube holders
- 1 adhesive split sheet 230 x 260 cm, split 20 x 100 cm, absorbent patches 75 x 140 cm, tube holders
- 1 instrument table cover 150 x 190 cm

Pack count: 1/3/6

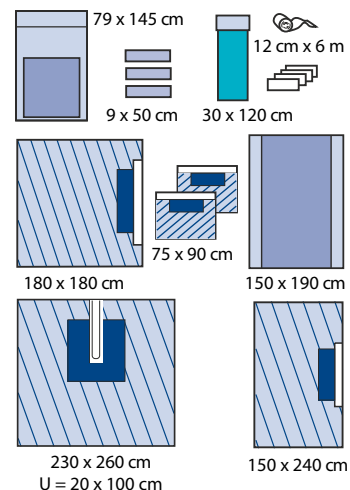

Extremity set

REF 120 030



- 2 op-tape 9 x 50 cm
- 1 Mayo stand cover 79 x 145 cm, reinforced
- 4 hand towel 30,5 x 34 cm
- 1 adhesive drape 75 x 90 cm
- 1 instrument table cover 150 x 190 cm, folded
- 1 extremity drape 230 x 300 cm, elastic aperture 7 cm, absorbent patches 50 x 100 cm, tube holders
- 1 instrument table cover 150 x 190 cm

Pack count: 1/4/8

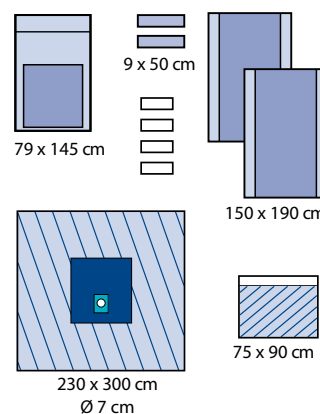

Extremity set

REF 120 031



- 2 op-tape 9 x 50 cm
- 1 Mayo stand cover 79 x 145 cm, reinforced
- 4 hand towel 30,5 x 34 cm
- 1 elastic stockinette 22 x 75 cm
- 1 utility drape 150 x 190 cm
- 1 extremity drape 230 x 300 cm, elastic aperture 7 cm, absorbent patches 50 x 100 cm, tube holders
- 1 instrument table cover 150 x 190 cm

Pack count: 1/4/8

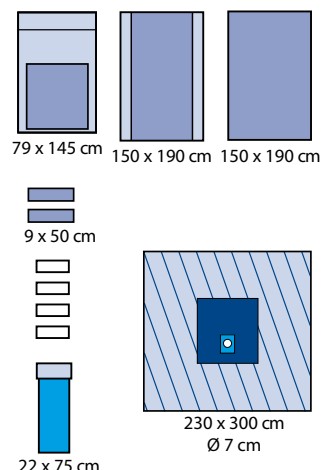

Extremity set ECO

REF 120 311



- 2 op-tape 9 x 50 cm
- 1 Mayo stand cover 79 x 145 cm, reinforced
- 4 hand towel 30,5 x 34 cm
- 1 stockinette 36 x 65 cm
- 1 extremity drape 230 x 300 cm, elastic aperture 7 cm, absorbent patches 75 x 80 cm, tube holders
- 1 instrument table cover 150 x 190 cm

Pack count: 1/6/12

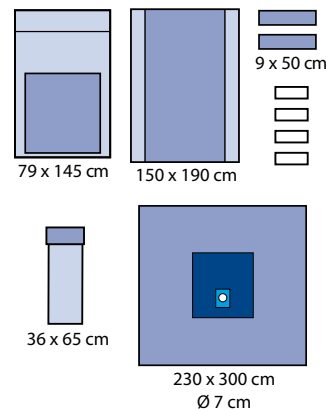

Hand/foot set

REF 120 032



- 1 Mayo stand cover 79 x 145 cm, reinforced
- 1 extremity drape 230 x 300 cm, elastic aperture 3,5 cm, absorbent patches 50 x 100 cm, tube holders
- 1 instrument table cover 150 x 190 cm

Pack count: 1/6/12

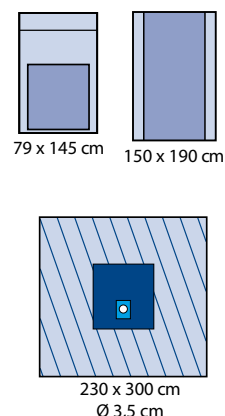

ORTHOPAEDIC SETS

Hand/foot set immunity

REF 120 325



- 1 op-tape 9 x 50 cm
- 1 Mayo stand cover 79 x 145 cm, reinforced
- 4 hand towel 30,5 x 34 cm
- 1 extremity drape 230 x 300 cm, elastic aperture 3,5 cm, absorbent patches 75 x 80 cm, tube holders
- 1 instrument table cover 150 x 190 cm

Pack count: 1/6/12

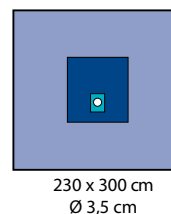
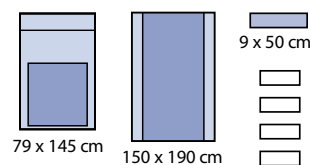

Bilateral extremity set

REF 120 034



- 2 op-tape 9 x 50 cm
- 4 hand towel 30,5 x 34 cm
- 1 extremity drape 200 x 300 cm, 2 x elastic aperture 6 cm, absorbent patches 90 x 150 cm, tube holders
- 1 instrument table cover 150 x 190 cm

Pack count: 1/4/8

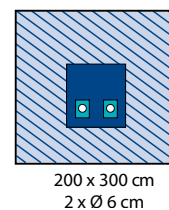
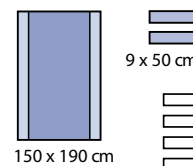

Knee arthroscopy set

REF 120 035



- 2 op-tape 9 x 50 cm
- 1 Mayo stand cover 79 x 145 cm, reinforced
- 4 hand towel 30,5 x 34 cm
- 1 elastic stockinette 22 x 75 cm
- 1 instrument table cover 150 x 190 cm, folded
- 1 knee arthroscopy drape 230 x 320 cm, fluid collection pouch 105 x 90 cm with sieve and suction port, reinforcement wire and 2 elastic apertures Ø 5 cm
- 1 instrument table cover 150 x 190 cm

Pack count: 1/4/8

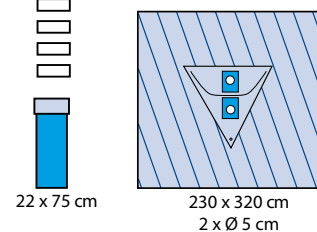
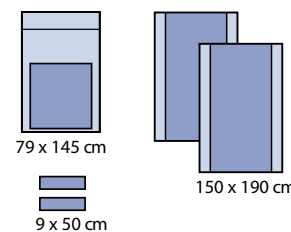

Knee arthroscopy set ECO

REF 120 355

- 1 op-tape 9 x 50 cm
- 1 Mayo stand cover 79 x 145 cm, reinforced
- 2 hand towel 30,5 x 34 cm
- 1 stockinette 36 x 65 cm
- 1 extremity drape 230 x 300 cm, elastic aperture 7 cm, absorbent patches 50 x 100 cm, tube holders
- 1 tube cover 15 x 240 cm, perforated tip
- 1 instrument table cover 140 x 150 cm

Pack count: 1/5/10

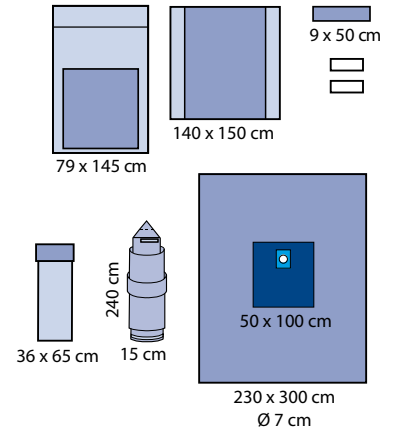

UROLOGY AND GYNAECOLOGY SETS

Gyn/Cyst set

REF 120 050

- 2 leggings 75 x 120 cm
- 1 utility drape 75 x 80 cm
- 1 gyn/cyst drape 75 x 175 cm, aperture 9 x 15 cm
- 1 instrument table cover 150 x 190 cm

Pack count: 1/5/20

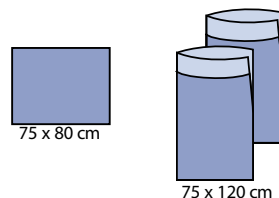
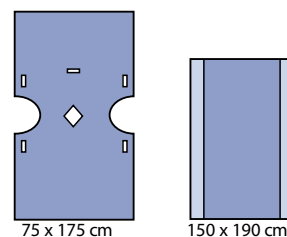

Gyn/Cyst set ECO

REF 120 055

- 2 leggings 75 x 120 cm
- 1 gyn/cyst drape 100 x 175 cm, adhesive aperture 9 x 15 cm
- 1 instrument table cover 100 x 150 cm

Pack count: 1/5/20

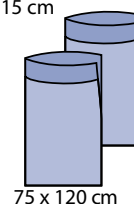
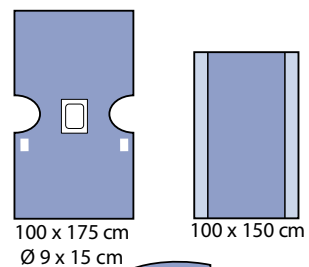

Gynecology set

REF 120 053

- 3 hand towel 30,5 x 34 cm
- 2 leggings 75 x 120 cm
- 1 drape 75 x 120 cm
- 1 gyn upper drape 115 x 150 cm
- 1 gyn lower drape 140 x 150 cm
- 1 instrument table cover 100 x 150 cm

Pack count: 1/4/16

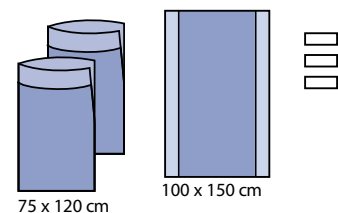
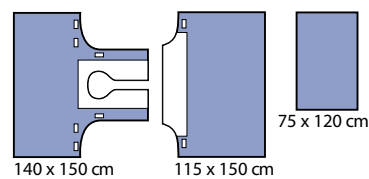

Delivery set

REF 120 550

- 6 hand towel 21 x 25 cm
- 1 underpad 60 x 60 cm
- 1 underpad 60 x 90 cm
- 1 baby sheet 56 x 75 cm
- 1 drape (stitching sheet) 75 x 120 cm
- 1 drape (for under the mother) 90 x 150 cm

Pack count: 1/12

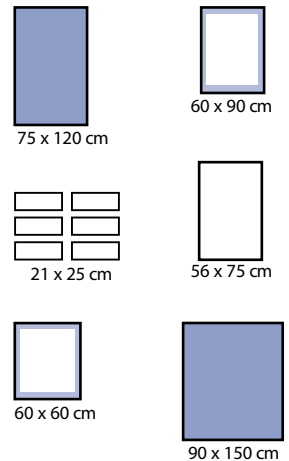

C-Section set I

REF 120 060

- 1 op-tape 9 x 50 cm
- 1 Mayo stand cover 79 x 145 cm, reinforced
- 4 hand towel 30,5 x 34 cm
- 1 baby sheet 75 x 120 cm
- 1 C-section drape 180/250 x 330 cm, fluid collection pouch 72 x 72 cm, incision film, aperture 16 x 18 cm, tube holders, 2 suction ports
- 1 instrument table cover 150 x 190 cm

Pack count: 1/5/10

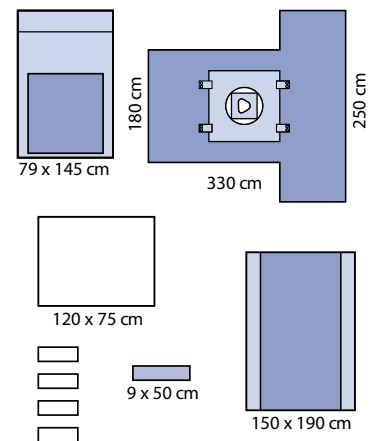

C-Section set II

REF 120 061

- 1 op-tape 9 x 50 cm
- 1 Mayo stand cover 79 x 145 cm, reinforced
- 4 hand towel 30,5 x 34 cm
- 1 baby sheet 75 x 120 cm
- 1 C-section drape 330 x 230 cm, fluid collection pouch 72 x 72 cm, integrated incision film 36 x 36 cm and tube holders, 2 suction ports
- 1 instrument table cover 150 x 190 cm

Pack count: 1/5/10

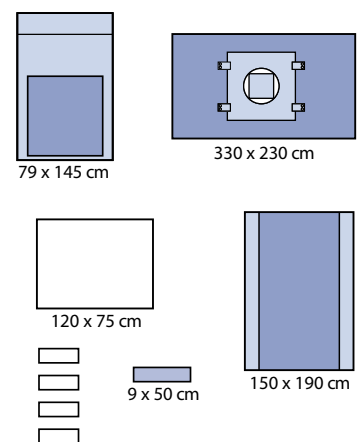

UROLOGY AND GYNAECOLOGY SETS

C-Section set Large

REF 120 062



- 1 op-tape 9 x 50 cm
- 1 Mayo stand cover 79 x 145 cm, reinforced
- 4 hand towel 30,5 x 34 cm
- 1 baby sheet 120 x 75 cm
- 1 C-section drape 330 x 230 cm, fluid collection pouch 102 x 112 cm with reinforcement with wire and foam, integrated incision film 36 x 36 cm and tube holders, 2 suction ports
- 1 instrument table cover 150 x 190 cm

Pack count: 1/3/6

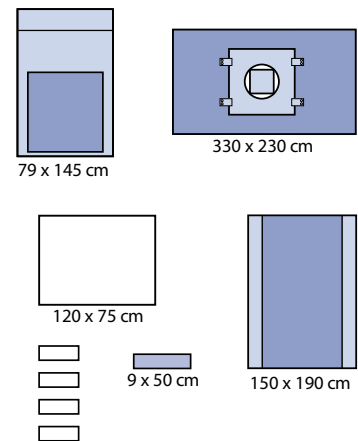

TUR set I

REF 120 070



- 1 op-tape 9 x 50 cm
- 2 leggings 75 x 120 cm
- 1 utility drape 75 x 80 cm
- 1 TUR drape 75 x 175 cm with finger cot Ø 3 cm (lower aperture), middle aperture Ø 6 cm and abdominal aperture Ø 8 cm
- 1 instrument table cover 150 x 190 cm

Pack count: 1/4/16

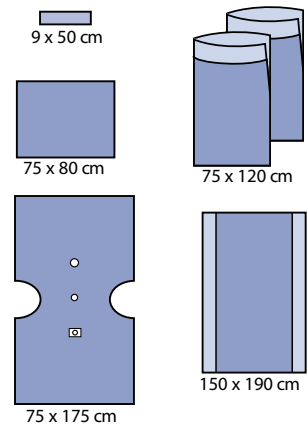

TUR set

REF 120 072



- 1 op-tape 9 x 50 cm
- 1 velcro tape 2,5 x 30 cm
- 1 hand towel 30,5 x 34 cm
- 1 TUR-drape 175/282 x 172 cm all-in-one, finger cot, apertures 6 cm and 8 cm (adhesive), integrated fluid collection pouch with sieve and suction port
- 1 instrument table cover 150 x 190 cm

Pack count: 1/6/12

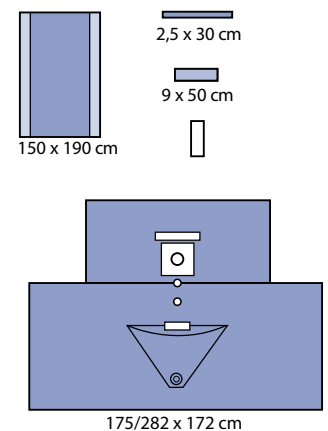

Abdomino-perineal set ECO

REF 120 485



- 2 op-tape 9 x 50 cm
- 1 Mayo stand cover 79 x 145 cm, reinforced
- 2 hand towel 30,5 x 34 cm
- 1 Gyn/Abdominal drape 215/240 x 350 cm all-in-one with integrated leg covers and fluid collection pouch, with sieve and suction port, 2 adhesive apertures: top 25 x 30 cm, bottom 9 x 15 cm (with integrated cover drape if apertures not used)
- 1 instrument table cover 150 x 190 cm

Pack count: 1/5/10

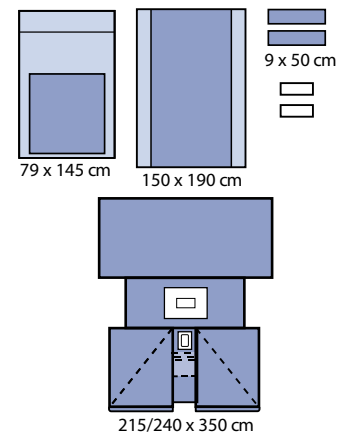

OPHTHALMIC SETS

Ophthalmic set

REF 120 080



- 1 hand towel 30,5 x 34 cm
- 1 ophthalmic drape 150 x 140 cm, with fluid collection pouch and integrated incision film with aperture 8 x 10 cm
- 1 instrument table cover 150 x 140 cm

Pack count: 1/7/28

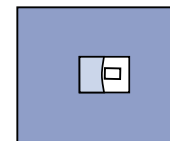

150 x 140 cm

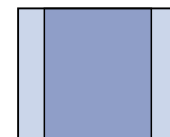

150 x 140 cm

Ophthalmic set II

REF 120 081



- 1 hand towel 30,5 x 34 cm
- 1 ophthalmic drape 150 x 140 cm, with fluid collection pouch and integrated incision film with oval aperture 3,5 x 6,5 cm
- 1 instrument table cover 150 x 140 cm

Pack count: 1/7/28

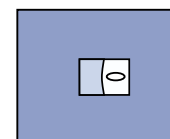

150 x 140 cm

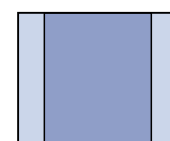

150 x 140 cm

Ophthalmic set

REF 120 082



- 1 incision film 10 x 12 cm
- 1 ophthalmic drape 150 x 180 cm, 2 fluid collection pouches, oval aperture 5 x 7 cm, 3 reinforcement wires
- 1 instrument table cover 150 x 140 cm

Pack count: 1/7/28

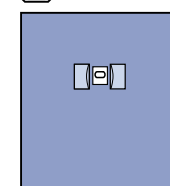

150 x 180 cm

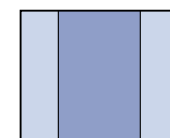

150 x 140 cm

OTHER SETS

Craniotomy set

REF 120 092



- 1 op-tape 9 x 50 cm
- 1 Mayo stand cover 79 x 145 cm, reinforced
- 2 hand towel 30,5 x 34 cm
- 4 adhesive drape 50 x 50 cm
- 1 Craniotomy drape 228 x 320 cm 2-layer integrated with critical field drape
 - 2 layer 75 cm x 90 cm with a hole 26 x 35 cm filled with PE 60 micron adhesive foil with an oval hole 20 x 14 cm, drape equipped with 2 stiffers in the longer sides, drape with an additional absorption area PP 80 g/m² 30 x 35 cm and a bag for liquids 52 x 64 cm PEVA 80 microns with filter and suction port. Drape equipped with 8 integrated velcro 2,5 x 14 cm organizers and 4 directional labels indicating application directions
- 1 instrument table cover 150 x 190 cm

Pack count: 1/5/10

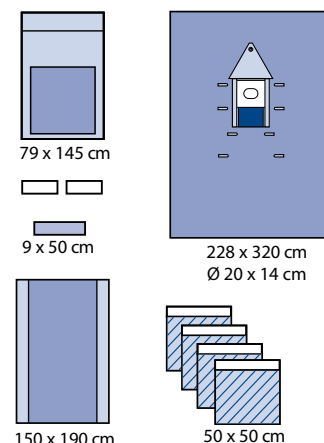

ENT set

REF 120 038



- 2 op-tape 9 x 50 cm
- 1 Mayo stand cover 79 x 145 cm, reinforced
- 4 hand towel 30,5 x 34 cm
- 1 adhesive drape 75 x 90 cm, absorbent patches 15 x 50 cm, tube holders
- 1 utility drape 75 x 80 cm
- 1 adhesive split sheet 150 x 250 cm, split 7 x 70 cm
- 1 instrument table cover 150 x 190 cm

Pack count: 1/5/10

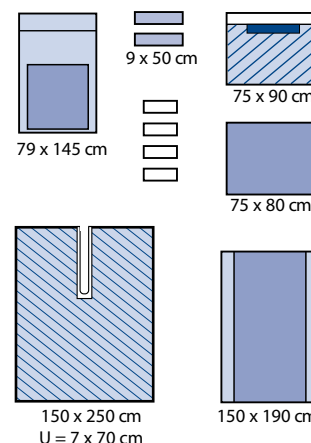

Laparoscopy set

REF 120 067



- 2 op-tape 9 x 50 cm
- 1 Mayo stand cover 79 x 145 cm, reinforced
- 4 hand towel 30,5 x 34 cm
- 1 laparoscopy drape 230 x 300 cm, aperture 25 x 20 cm
- 1 fluid collection pouch 30 x 40 cm
- 1 instrument table cover 150 x 190 cm

Pack count: 1/7/14

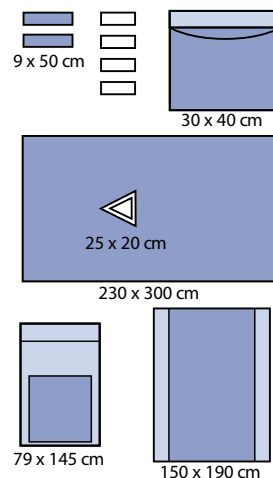

SPECIALITY DRAPES

Adhesive split sheets

REF 130 008

150 x 183 cm, split 7 x 70 cm
Pack count: 1/9/36

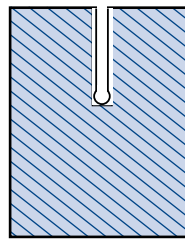

150 x 183 cm
U = 7 x 70 cm

REF 130 009

230 x 290 cm, split 20 x 100 cm, absorbent patch 150 x 100 cm, tube holders
2 splits 6 x 90 cm
Pack count: 1/8/16

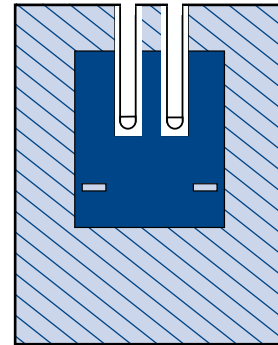

230 x 290 cm
U = 6 x 90 cm

REF 130 010

150 x 250 cm, split 7 x 70 cm, absorbent patch 50 x 50 cm, tube holders
Pack count: 1/8/32

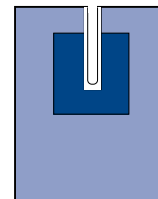

150 x 250 cm
U = 7 x 70 cm

REF 130 015

230 x 260 cm, split 10 x 100 cm, absorbent patch 75 x 140 cm, tube holders
Pack count: 1/8/16

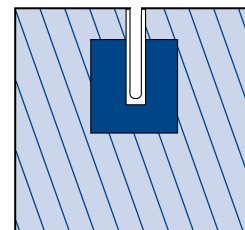

230 x 260 cm
U = 10 x 100 cm

REF 130 018

200 x 260 cm, split 7 x 100 cm, absorbent patch 75 x 140 cm, tube holders
Pack count: 1/9/18

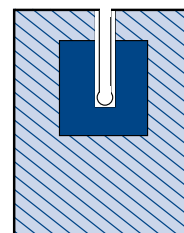

200 x 260 cm
U = 7 x 100 cm

REF 1230612102

230 x 260 cm, split 20 x 85 cm, absorbent patch 50 x 100 cm, tube holders
Pack count: 1/8/16

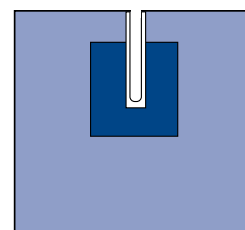

230 x 260 cm
U = 20 x 85 cm

SPECIALITY DRAPES

Hand/foot drape

REF 130 020

150 x 180 cm, elastic aperture Ø 3,5 cm, absorbent patch 50 x 100 cm, tube holders

Pack count: 1/17/34

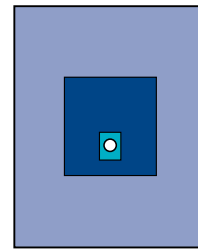

150 x 180 cm
Ø 3,5 cm

REF 130 024

230 x 300 cm, elastic aperture Ø 3,5 cm, absorbent patch 50 x 100 cm, tube holders

Pack count: 1/8/16

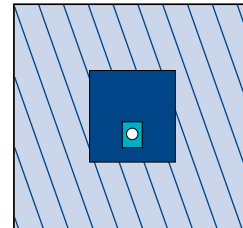

230 x 300 cm
Ø 3,5 cm

Knee arthroscopy drape

REF 130 028

230 x 320 cm, with fluid collection pouch with sieve and bottom outlet, 2 elastic aperture Ø 5 cm

Pack count: 1/7/14

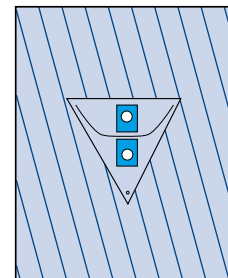

230 x 320 cm
2x Ø 5 cm

Extremity drape

REF 130 025

230 x 300 cm, elastic aperture Ø 7 cm, absorbent patch 50 x 100 cm, tube holders

Pack count: 1/8/16

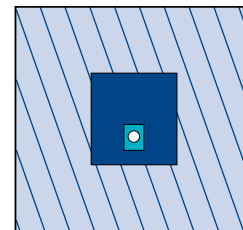

230 x 300 cm
Ø 7 cm

Vertical drapes

REF 130 030

240 x 330 cm, incision film 40 x 30 cm, integrated fluid collection pouch with sieve and bottom outlet, 2 tube holders and 2 compartment suction/diathermy pouches, 24 x 24 cm

Pack count: 1/14/28

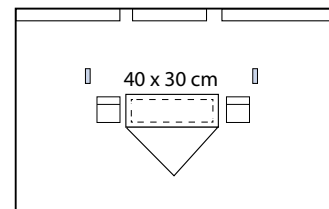

330 x 240 cm

REF 130 032

240 x 330 cm, incision film 86 x 25 cm, integrated fluid collection pouch with sieve and bottom outlet, 2 tube holders and 2 compartment suction/diathermy pouches, 24 x 24 cm

Pack count: 1/10/20

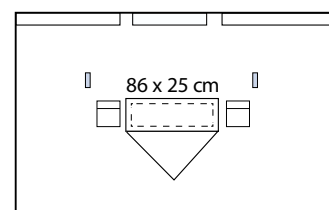

330 x 240 cm

SPECIALITY DRAPES

Laparoscopy drapes

REF 130 065

230 x 300 cm, triangular aperture 25 x 20 cm
Pack count: 1/9/18

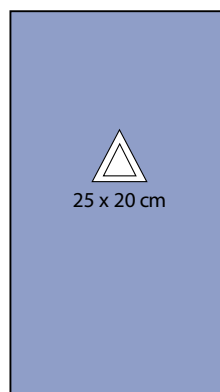

25 x 20 cm

230 x 300 cm

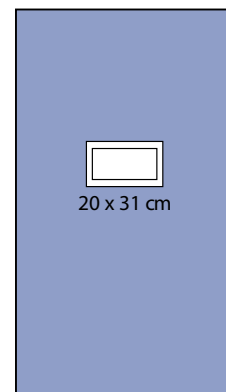

20 x 31 cm

230 x 300 cm

REF 130 066

230 x 300 cm, aperture 20 x 31 cm
Pack count: 1/9/18

Variable aperture drapes

REF 150 011

37 x 65 cm, 2 drapes (repositionable)
Pack count: 1/25/100

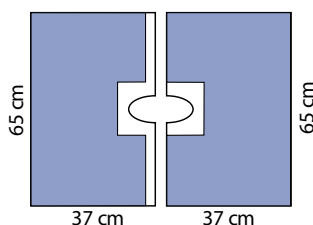

65 cm

65 cm

37 cm

37 cm

REF 150 012

50 x 75 cm, 2 drapes
Pack count: 1/35/140

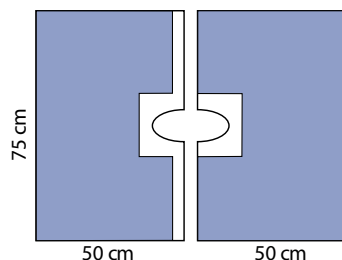

75 cm

75 cm

50 cm

50 cm

REF 150 013

75 x 100 cm, 2 drapes
Pack count: 1/20/80

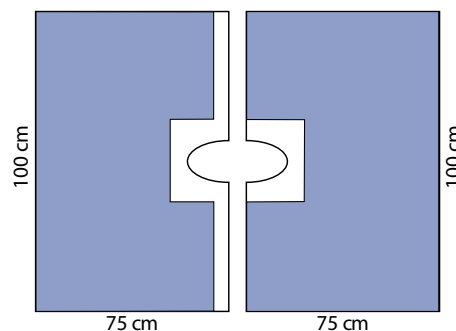

100 cm

100 cm

75 cm

75 cm

Ophthalmic drapes

REF 1230618103

120 x 120 cm, aperture 7 x 9 cm, with incision foil and fluid collection pouch
Pack count: 1/40/80

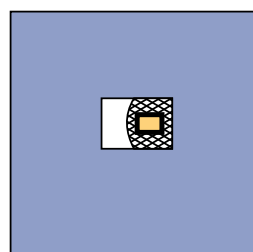

120 x 120 cm

REF 1230618104

150 x 150 cm, aperture 7 x 9 cm, with incision foil
Pack count: 1/30/60

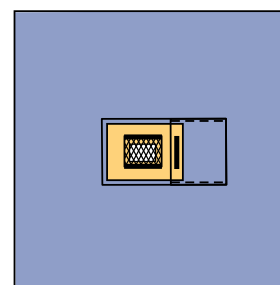

150 x 150 cm

UTILITY DRAPES + HOSPIDRAPE

Utility drapes

REF 140 010

50 x 60 cm
Pack count: 1/45/180



50 x 60 cm



75 x 90 cm



90 x 120 cm

REF 140 015

75 x 90 cm
Pack count: 1/25/100

REF 1230612207

90 x 120 cm
Pack count: 1/70/140

REF 1230612208

100 x 150 cm
Pack count: 1/45/90



100 x 150 cm



150 x 180 cm

REF 1230612209

150 x 180 cm
Pack count: 1/60/60

Hospidrape (Cellulose /PE) - AMBULATORY DRAPES

REF 1230612001

38 x 45 cm
Pack count: 1/90/720



38 x 45 cm

REF 1230612002

50 x 60 cm
Pack count: 1/100/400



50 x 60 cm

REF 1230612003

45 x 75 cm
Pack count: 1/110/440



45 x 75 cm

REF 1230612004

75 x 90 cm
Pack count: 1/120/240



75 x 90 cm

REF 1230612005

90 x 120 cm
Pack count: 1/90/180



90 x 120 cm

REF 1230612006

75 x 210 cm
Pack count: 1/60/120



75 x 210 cm

ADHESIVE DRAPES

Adhesive drapes - 2-layers

REF 140 055

50 x 60 cm

Pack count: 1/40/160

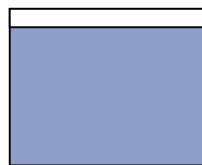

50 x 60 cm



75 x 90 cm

REF 140 045

75 x 90 cm

Pack count: 1/100/200

REF 140 050

150 x 240 cm

Pack count: 1/12/48

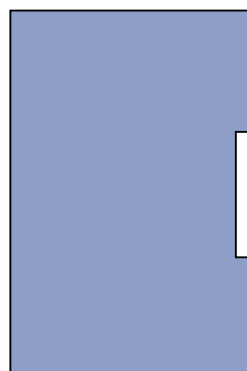

150 x 240 cm

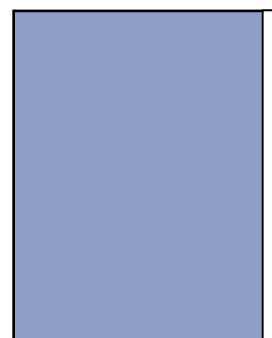

90 x 120 cm

REF 140 046

90 x 120 cm

Pack count: 1/65/130

REF 140 047

100 x 150 cm

Pack count: 1/40/80

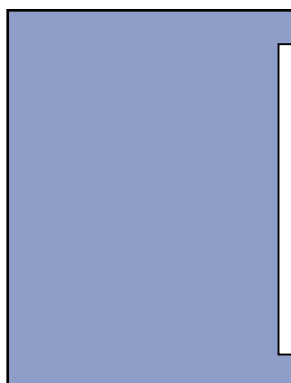

100 x 150 cm

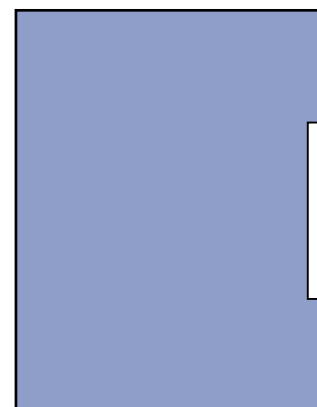

150 x 180 cm

REF 140 048

150 x 180 cm

Pack count: 1/55/55

REF 140 049

180 x 180 cm

Pack count: 1/4/16

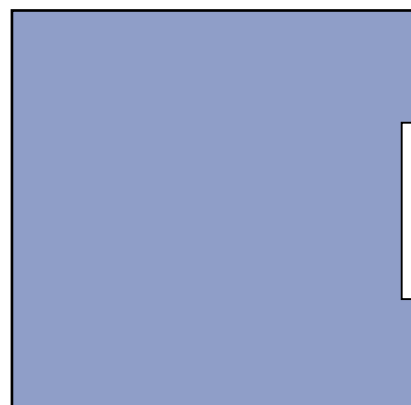

180 x 180 cm

ADHESIVE DRAPES

Adhesive drapes - 3-layer

REF 140 056

37,5 x 45 cm
Pack count: 1/60/240

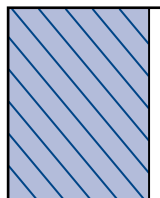

37,5 x 45 cm

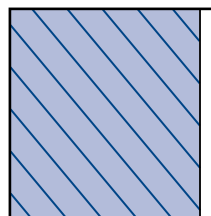

50 x 50 cm

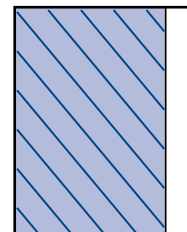

45 x 75 cm

REF 140 052

50 x 50 cm
Pack count: 1/100/200

REF 140 051

45 x 75 cm
Pack count: 1/12/48

REF 140 061

75 x 75 cm
Pack count: 1/65/130

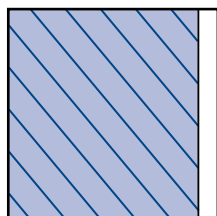

75 x 75 cm

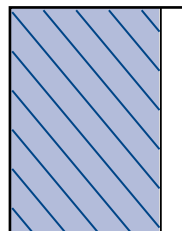

75 x 90 cm

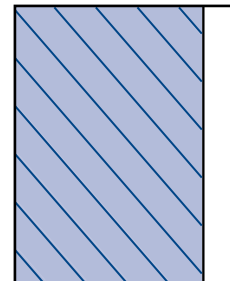

75 x 100 cm

REF 140 060

75 x 90 cm
Pack count: 1/16/64

REF 140 054

75 x 100 cm
Pack count: 1/15/60

REF 140 053

100 x 100 cm
Pack count: 1/40/80

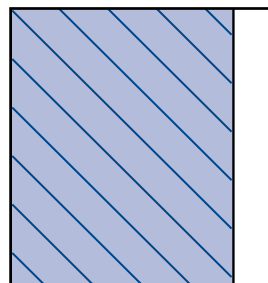

100 x 100 cm

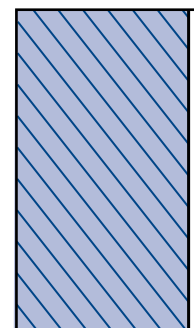

180 x 254 cm

REF 140 064

180 x 254 cm
Pack count: 1/55/55

Adhesive drape Medium

REF 140 065

180 x 180 cm
Pack count: 1/8/32

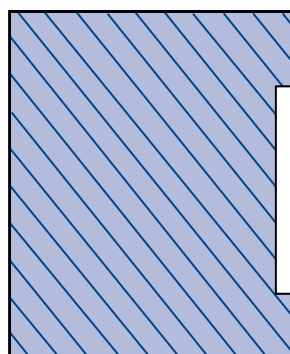

180 x 180 cm

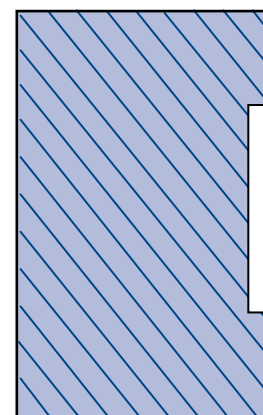

150 x 240 cm

Adhesive drape Large

REF 140 070

150 x 240 cm
Pack count: 1/8/32

APERTURE DRAPES AND ADHESIVE APERTURE DRAPES

Aperture drapes

REF 150 055

50 x 60 cm, Ø 6 x 8 cm
Pack count: 1/45/180

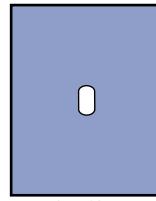

50 x 60 cm
Ø 6 x 8 cm

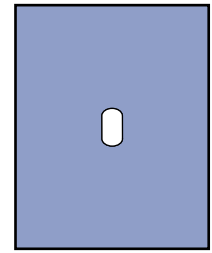

75 x 90 cm
Ø 6 x 8 cm

REF 150 065

75 x 90 cm, Ø 6 x 8 cm
Pack count: 1/25/100

Adhesive aperture drapes

REF 150 005

50 x 60 cm, Ø 6 x 8 cm
Pack count: 1/45/180

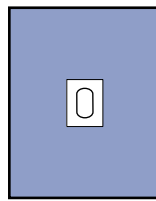

50 x 60 cm
Ø 6 x 8 cm

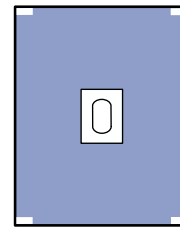

75 x 80 cm
Ø 6 x 15 cm

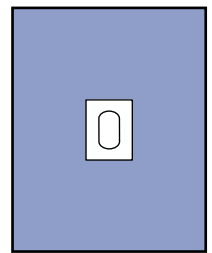

75 x 90 cm
Ø 6 x 8 cm

REF 150 010

75 x 80 cm, Ø 6 x 15 cm
Pack count: 1/25/100

REF 150 015

75 x 90 cm, Ø 6 x 8 cm
Pack count: 1/25/100

REF 150 017

100 x 125 cm, Ø 11 cm
Pack count: 1/20/80

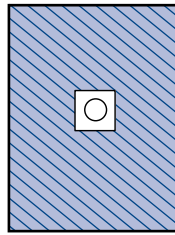

100 x 125 cm
Ø 11 cm

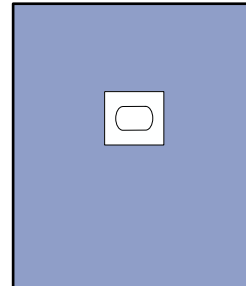

120 x 150 cm
Ø 5 x 7 cm

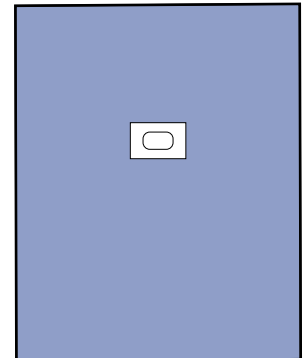

150 x 180 cm
Ø 5 x 7 cm

REF 150 020

120 x 150 cm, Ø 5 x 7 cm
Pack count: 1/20/80

REF 150 025

150 x 180 cm, Ø 5 x 7 cm
Pack count: 1/14/56

REF 150 030

150 x 180 cm, Ø 6 x 15 cm
Pack count: 1/12/48

REF 150 035

230 x 250 cm, Ø 12 cm
Pack count: 1/7/28

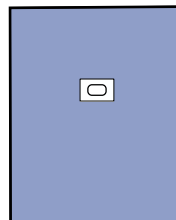

150 x 180 cm
Ø 6 x 15 cm

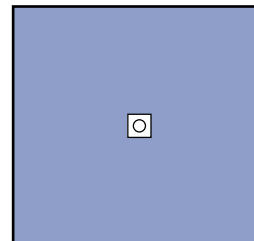

230 x 250 cm
Ø 12 cm

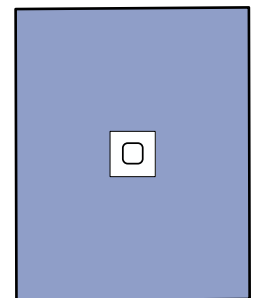

200 x 280 cm
Ø 14 cm

REF 150 037

200 x 280 cm, Ø 14 cm
Pack count: 1/7/28

APERTURE DRAPES AND ADHESIVE APERTURE DRAPES

REF 150 038

200 x 240 cm, Ø 12 cm
Pack count: 1/9/36

REF 150 039

200 x 280 cm, Ø 15 cm
Pack count: 1/7/28

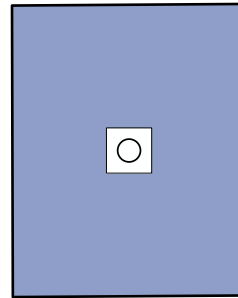

200 x 240 cm
Ø 12 cm

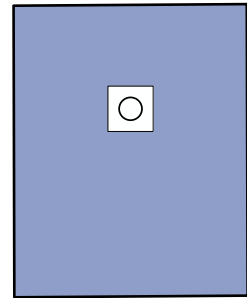

200 x 280 cm
Ø 15 cm

REF 1230612310

180 x 280 cm, Ø 14 cm
Pack count: 1/14/28

REF 1230612320

120 x 150 cm, Ø 12 cm
Pack count: 1/40/80

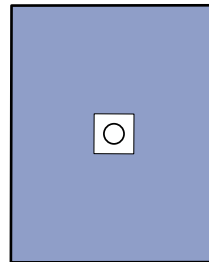

120 x 150 cm
Ø 12 cm

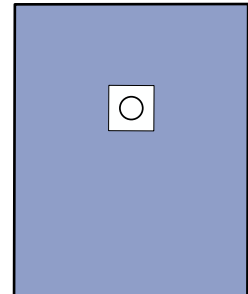

180 x 280 cm
Ø 14 cm

TABLE COVERS AND COMPONENTS

Instrument Table Cover

REF 170 015

100 x 150 cm
Pack count: 1/18/72

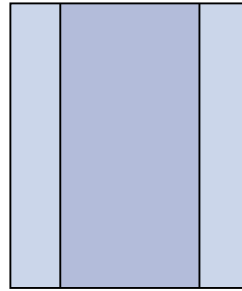

100 x 150 cm

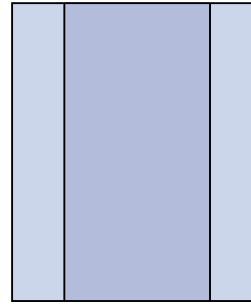

140 x 150 cm

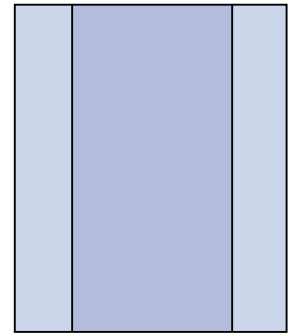

150 x 190 cm

REF 170 020

140 x 150 cm
Pack count: 1/16/64

REF 170 025

150 x 190 cm
Pack count: 1/15/60

Mayo stand cover reinforced

REF 170 012

79 x 145 cm
Pack count: 1/20/80

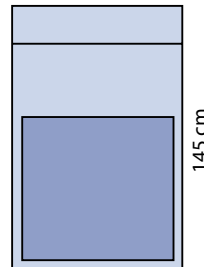

79 cm

145 cm

Adhesive OP-tapes

REF 140 093

10 x 50 cm, transparent
Pack count: 1/10/200

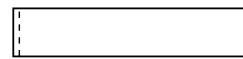

10 x 50 cm
transparent

REF 140 094

9 x 50 cm, repositionable
Pack count: 1/10/200

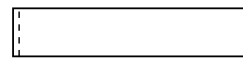

9 x 50 cm
repositionable

REF 140 095

9 x 50 cm, 1 pcs.
Pack count: 1/100/400



9 x 50 cm

REF 140 096

9 x 50 cm, 2 pcs.
Pack count: 2/120/480



9 x 50 cm
2 pcs

EQUIPMENT DRAPES

Tube covers

REF 180 010

8 x 120 cm, simple tip
Pack count: 1/65/260

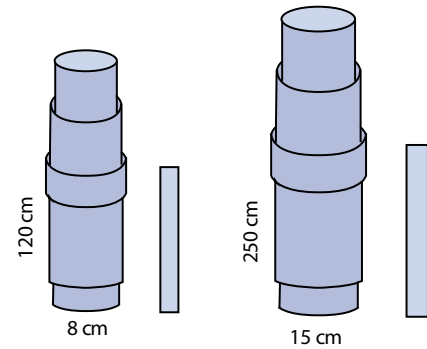

REF 180 015

15 x 250 cm, simple tip
Pack count: 1/30/120

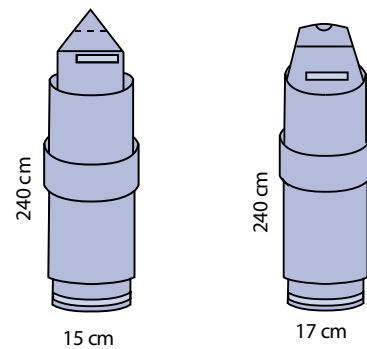

REF 180 020

15 x 240 cm, perforated tip
Pack count: 1/30/120

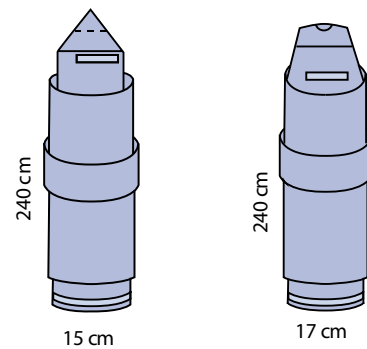

REF 180 025

17 x 240 cm, elastic tip
Pack count: 1/30/120

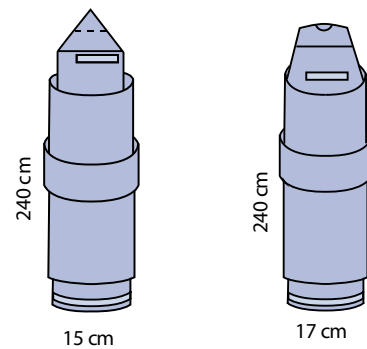

REF 180 030

15 x 230 cm, ring insert
Narrow necked simple tip
Pack count: 1/12/48

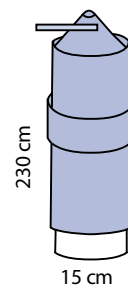

Banded Bags & Dome Bags

REF 180 050

Ø 90 cm
Pack count: 1/18/72

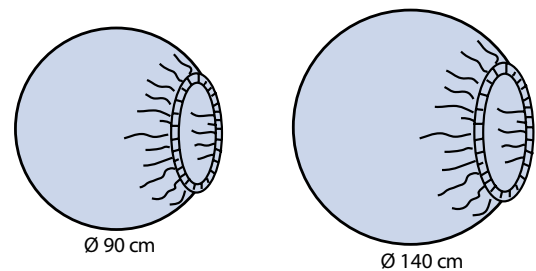

REF 180 055

Ø 140 cm
Pack count: 1/10/40

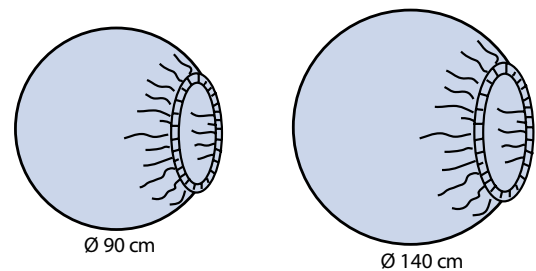

Device sleeve

REF 1326003215

90 x 100 cm
Pack count: 1/12/48

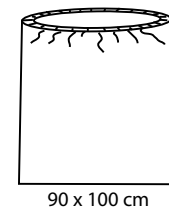

Universal Long Handle

REF 14-1683 EU

Universal Long Handle, Guard (Light Handle Cover), sterile
Pack count: 100

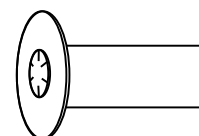

INCISION FILM

Incision film**REF 1230610101**

15 x 20 cm

Pack count: 1/120/480

REF 1230610102

30 x 20 cm

Pack count: 1/100/200

REF 1230610103

45 x 20 cm

Pack count: 1/15/240

REF 1230610104

40 x 35 cm

Pack count: 1/40/40

REF 1230610105

45 x 50 cm

Pack count: 1/30/30

REF 1230610106

45 x 65 cm

Pack count: 1/30/30

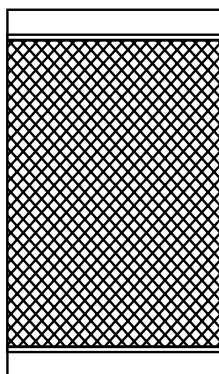

ACCESSORIES

Arm cover

REF 1230613110

Pack count: 1/100/200

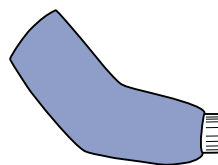

Leggings

REF 130 090

75 x 120 cm, 2 pcs/bag

Pack count: 2/18/72

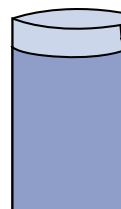

75 x 120 cm
2 pcs

Elastic stockinettes

REF 130 095

30 x 120 cm, size L, + 2 x OP tape 9 x 50 cm

Pack count: 1/10/40

REF 130 096

22 x 75 cm, size S, + 2 x OP tape 9 x 50 cm

Pack count: 1/20/80

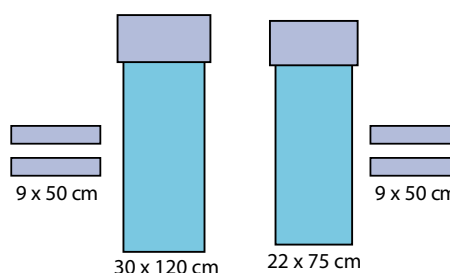

Fluid collection pouches

REF 180 070

30 x 40 cm, 1 chamber

Pack count: 1/55/220

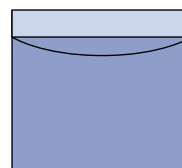

30 x 40 cm

REF 180 072

30 x 40 cm (30 cm x 15 cm + 25 cm), 2 chambers, suction and diathermy bag

Pack count: 1/55/220

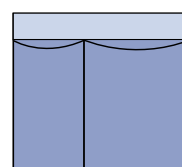

30 x 40 cm

REF 180 073

62 x 50 cm, sieve and outlet

Pack count: 1/11/44

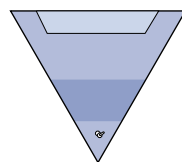

62 x 50 cm

REF 180 076

Arthroscopy pouch, 63/93 x 76 cm, oval adhesive aperture 17 x 23 cm, 2 foam wire reinforcement, 2 outlet ports

Pack count: 1/11/44

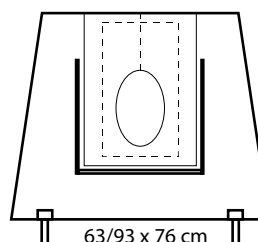

63/93 x 76 cm

SURGICAL GOWNS

SMMMS

SR - BASIC

Open back, for dry operation of short duration

Ref number	Size	Units in carton
250 032	123 cm, L without hand towels	1/20/40
250 033	147 cm, XL without hand towels	1/18/36



SR - Standard

Universal gown, for dry operations

Ref number	Size	Units in carton
250 022	125 cm, M without hand towels	1/20/40
250 023	135 cm, L without hand towels	1/20/40
250 024	145 cm, XL without hand towels	1/18/36
250 025	155 cm, XXL without hand towels	1/18/36
250 027	125 cm, M with 2 hand towels	1/20/40
250 028	135 cm, L with 2 hand towels	1/20/40
250 029	145 cm, XL with 2 hand towels	1/18/36
250 030	155 cm, XXL with 2 hand towels	1/18/36

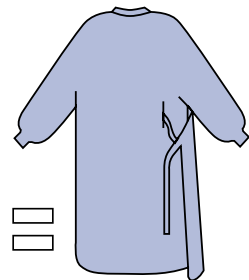
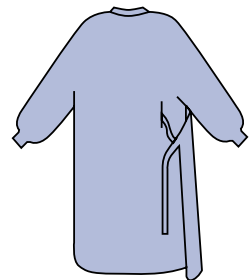

SR - Special

Reinforced for wet operations

Ref number	Size	Units in carton
250 052	126 cm, M without hand towels	1/20/40
250 053	137 cm, L without hand towels	1/20/40
250 054	147 cm, XL without hand towels	1/18/36
250 055	155 cm, XXL without hand towels	1/18/36
250 057	126 cm, M with 2 hand towels	1/20/40
250 058	137 cm, L with 2 hand towels	1/20/40
250 059	147 cm, XL with 2 hand towels	1/18/36
250 060	155 cm, XXL with 2 hand towels	1/18/36

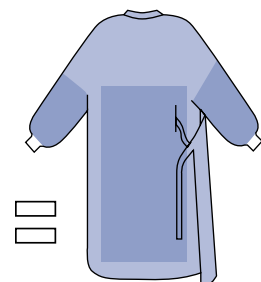
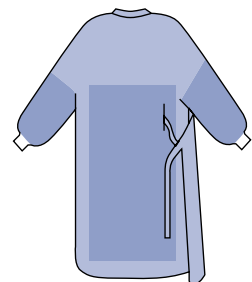

LABEL INFORMATION IN ACCORDANCE WITH EN ISO 15223-1 AND EN 1041+A1

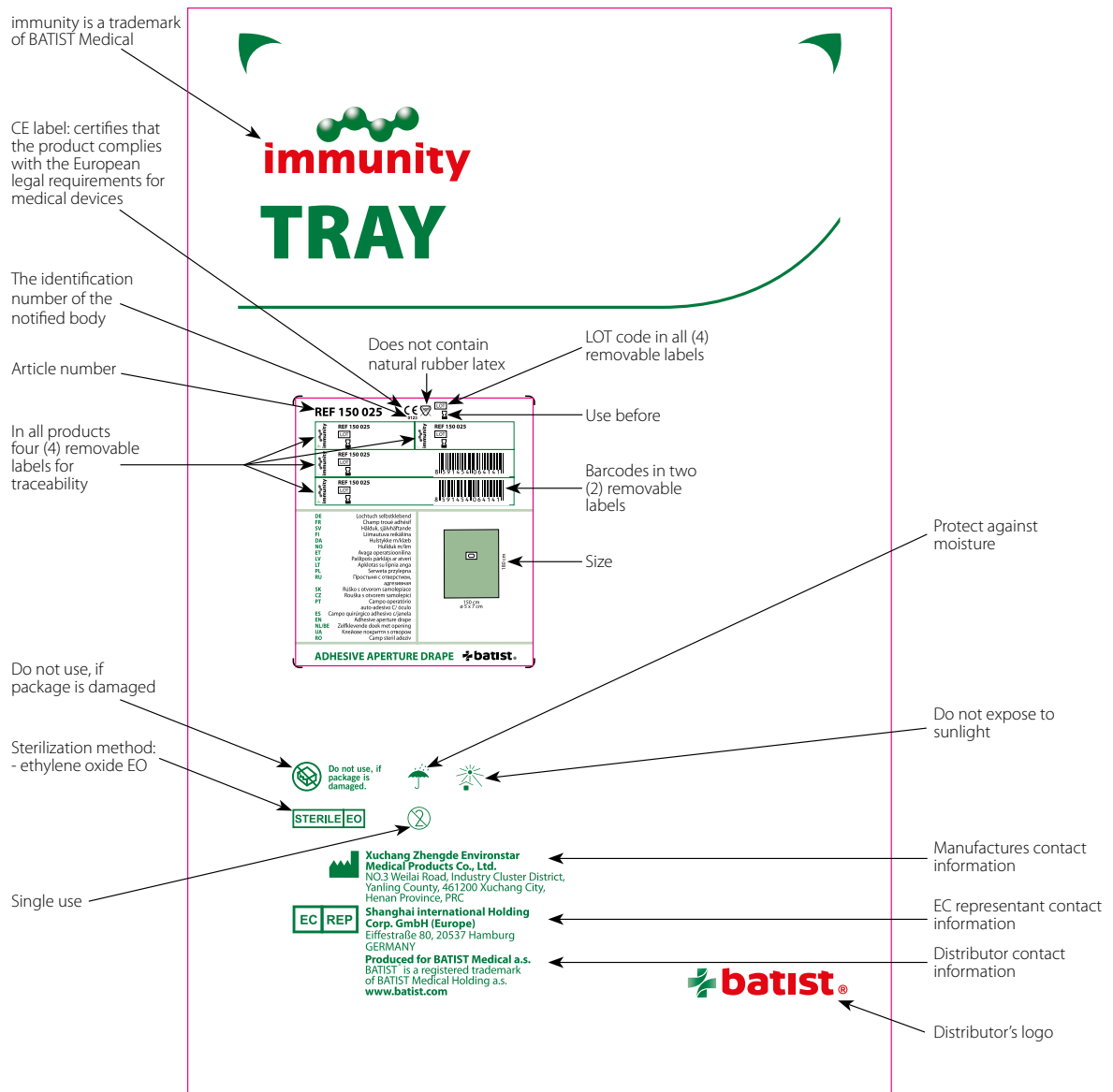

TRIPLE PACKAGING SYSTEM

Three-piece packaging system

1. Brown transport carton
2. Dispenser - white carton box with perforated smaller side
3. Single package

Label information in line with EN ISO 15223 and EN 1041

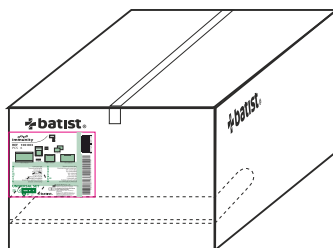
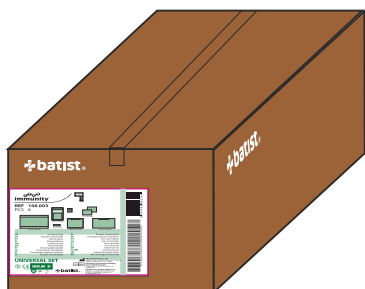



immunity

PRODUCT CATALOGUE

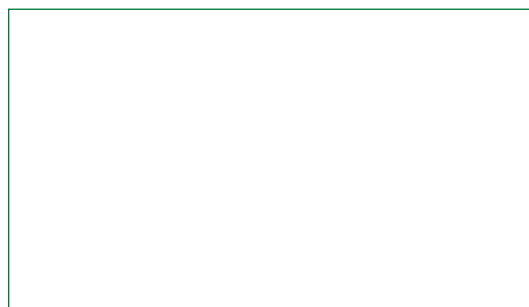

BATIST Medical a.s.
Nerudova 309
549 41 Červený Kostelec
Česká republika

tel.: +420 491 413 311
fax: +420 491 413 394
www.batist.com

